

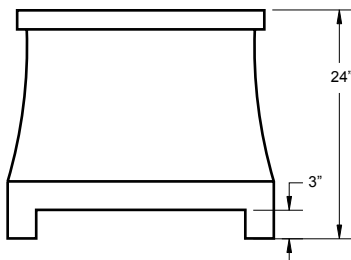

FRENCH SHROUD

Decorative chimney tops are an attractive addition to any fireplace. Hand-crafted designs are created to compliment a variety of architectural styles.

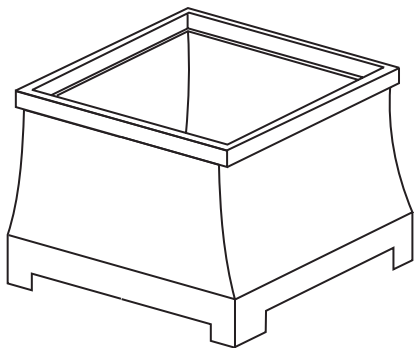

SIDE ELEVATION

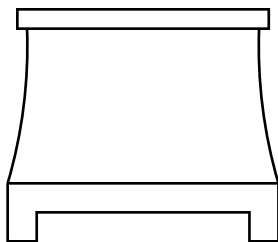

END ELEVATION

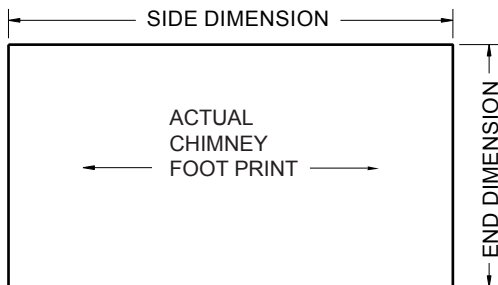

- | | |
|--------------------------------------|---|
| MATERIAL | FINISH |
| <input type="checkbox"/> COPPER | <input type="checkbox"/> NATURAL MILL |
| <input type="checkbox"/> GALV. STEEL | <input type="checkbox"/> PATINA ON COPPER |
| <input type="checkbox"/> LEAD/COPPER | <input type="checkbox"/> PAINTED |
| <input type="checkbox"/> ZINC | <input type="checkbox"/> ANTIQUED |
| <input type="checkbox"/> ALUMINUM | <input type="checkbox"/> PAINT-GRIP STEEL |

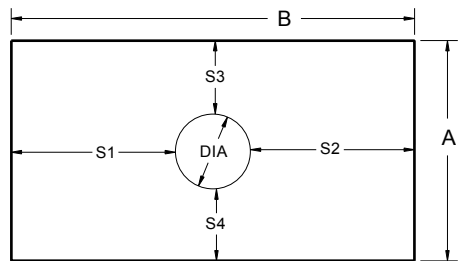

MEASURED IN INCHES

A	
B	
C	
DIA	



SINGLE PORT CHIMNEY CAP

S1	
S2	
S3	
S4	

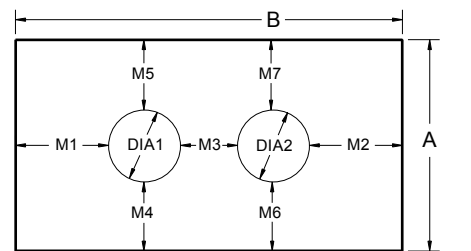

MEASURED IN INCHES

A	
B	
C	
M1	
M2	
DIA1	

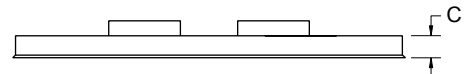

MULTI PORT CHIMNEY CAP

M3	
M4	
M5	
M6	
M7	
DIA2	

NOTE:
 Chimney Cap flashings are sold separately.
 End user should verify conformance with state and local building code enforcement agency. Some areas have restrictions regarding the use of decorative shrouds on existing factory-built fireplaces. Installation of the product may void fireplace manufacturers warranty.